

"A" AND "K" SERIES ADAPTABLE REPLACEMENT COLD CONTROLS

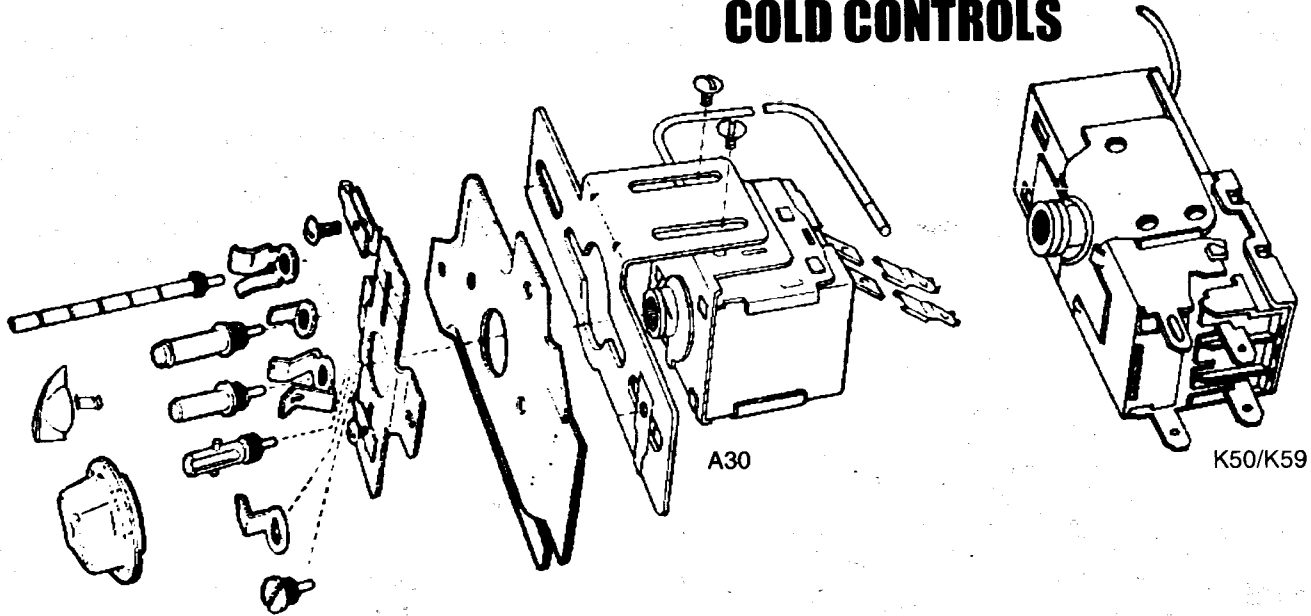

INSTALLATIONS

1. Disconnect electrical power.
2. Remove inoperative control.
3. Select required dial shaft parts and prong drivers matching the original control to the replacement control.
4. Mount horizontal bracket to control using only 1/8" long mounting screws. Longer screws will protrude into the control and affect the control's operation.
5. Move bracket forward or backwards until the proper shaft length has been attained. The two retaining screws should be tightened. Refer to Figure 1.

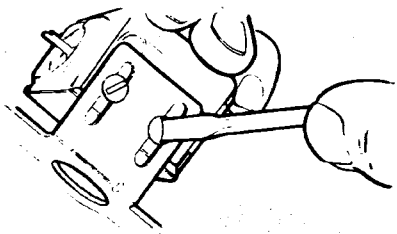

Figure 1
Horizontal Bracket Mounting

6. Space two Tinnerman nuts on bracket to correspond with original mounting hole spacings. It may be necessary to shorten the mounting

bracket due to interface. This can be done by bending and breaking the bracket at one of the serrations. Refer to Figure 2.

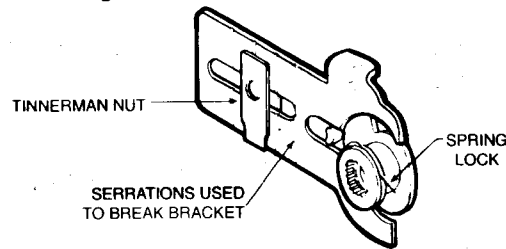

Figure 2
Tinnerman Nut Spacing and Serration Breakoff

7. Rotate the dial shaft to "off" position on both original and replacement control.
8. Review prong drivers and dial shaft position at "off". Shaft and drivers should match the same physical position as the original. If necessary to remove the adaptable shaft, press the spring lock counter clockwise while lifting the shaft. Reposition the adaptable shaft as required. See Figure 2.
9. Mount the capillary tube in the same position as the original control capillary. Coil any excess capillary and store behind the control.
10. Wire and mount the replacement control the same as the original. Make sure the control ground wire is attached and grounded to the unit.

11. Attach dial knob on replacement control, locating "off" position of dial the same as on the original.
12. Turn dial to normal position or mid-scale position.
13. Turn on electrical power and check the control's operation. Allow sufficient time for the unit to reach normal operating temperature.
14. Readjust the dial knob colder or warmer, as required.

MOUNTING COLD CONTROLS WITH ORIGINAL MOUNTING BRACKET'S HARDWARE

1. Select required mounting bracket that matches the original. Figure 4.
2. Place the universal bracket over the replacement control as shown in Figure 3.

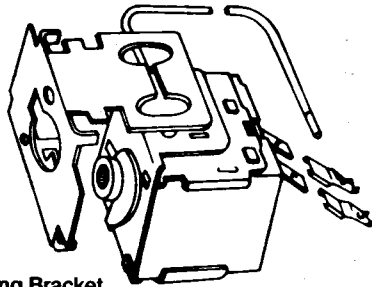

Figure 3
Universal Mounting Bracket

3. Use 1/8" long mounting screws to mount universal bracket to the side of the replacement control.
4. Mount selected mounting bracket on the universal bracket by matching the two mounting holes. Use two 1/8" long mounting screws to retain the bracket.

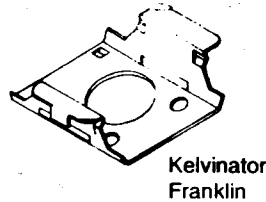
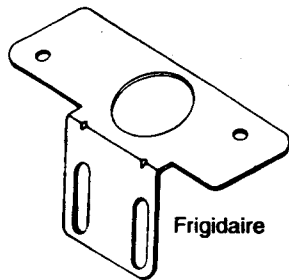
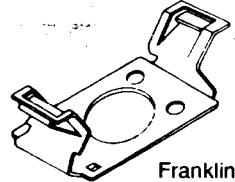
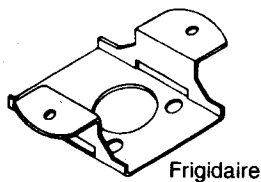

Figure 4
Mounting Hardware Brackets



Bulletin No. 1531009-1118

RANCO

CONTROLS DIVISION 8115 U.S. Route 42 North Plain City, Ohio 43064 U.S.A.

Ranco is a multi-national manufacturer of environmental comfort, convenience and safety control devices, and systems automatically regulating temperature, pressure, time, current, flow, and humidity.

Copyright Ranco, Inc.
All rights reserved 1981

FRIGIDAIRE DIAL SHAFT AND DRIVER ASSEMBLY

1. Select and insert adaptable dial shaft shown in Figure 5 to the control.
2. Select Frigidaire dial knob drivers that are similar to the original control. See Figure 5.
3. Place selected dial knob driver on the above adaptable dial shaft.
4. Mount original dial knob on shaft. Turn dial knob to "off". Compare "off" position with original. If necessary, the adaptable dial shaft and knob can be repositioned as required. Review steps 1 thru 14 for further installation requirements.

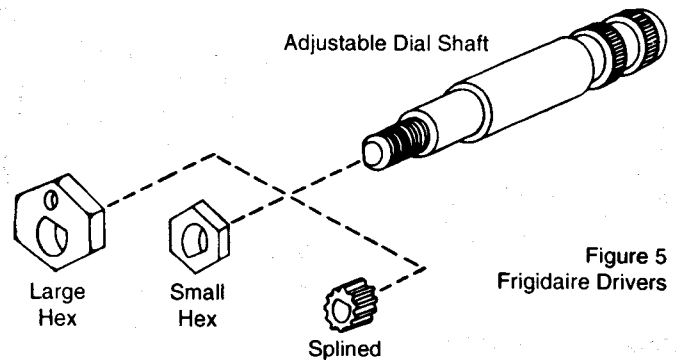
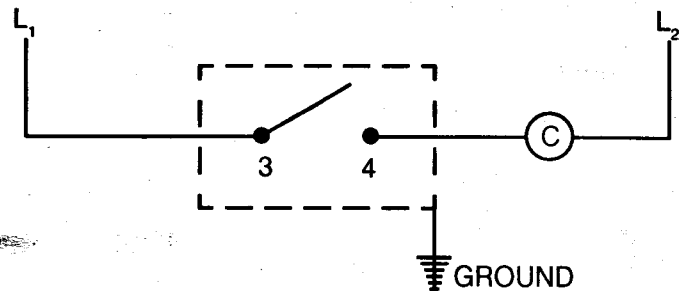

Figure 5
Frigidaire Drivers

ELECTRICAL RATINGS

	A10/A12		A30	A30	K50/K59/A59
VOLTS A.C.	120	240	120/240	277	120/240
AMPS:					
FULL LOAD	16	8	20	16	10/6
LOCKED ROTOR	84	41	80	60	40/36

WIRING DIAGRAM



1000